

Dimensions - Hard-Tail Style Stetsbar

This document shows a top down view of the Hard-Tail style baseplate and provides measurements for all of the critical dimensions that may be needed to ensure the unit will fit correctly to the guitar.

For more information please contact your regional Stetsbar support center.

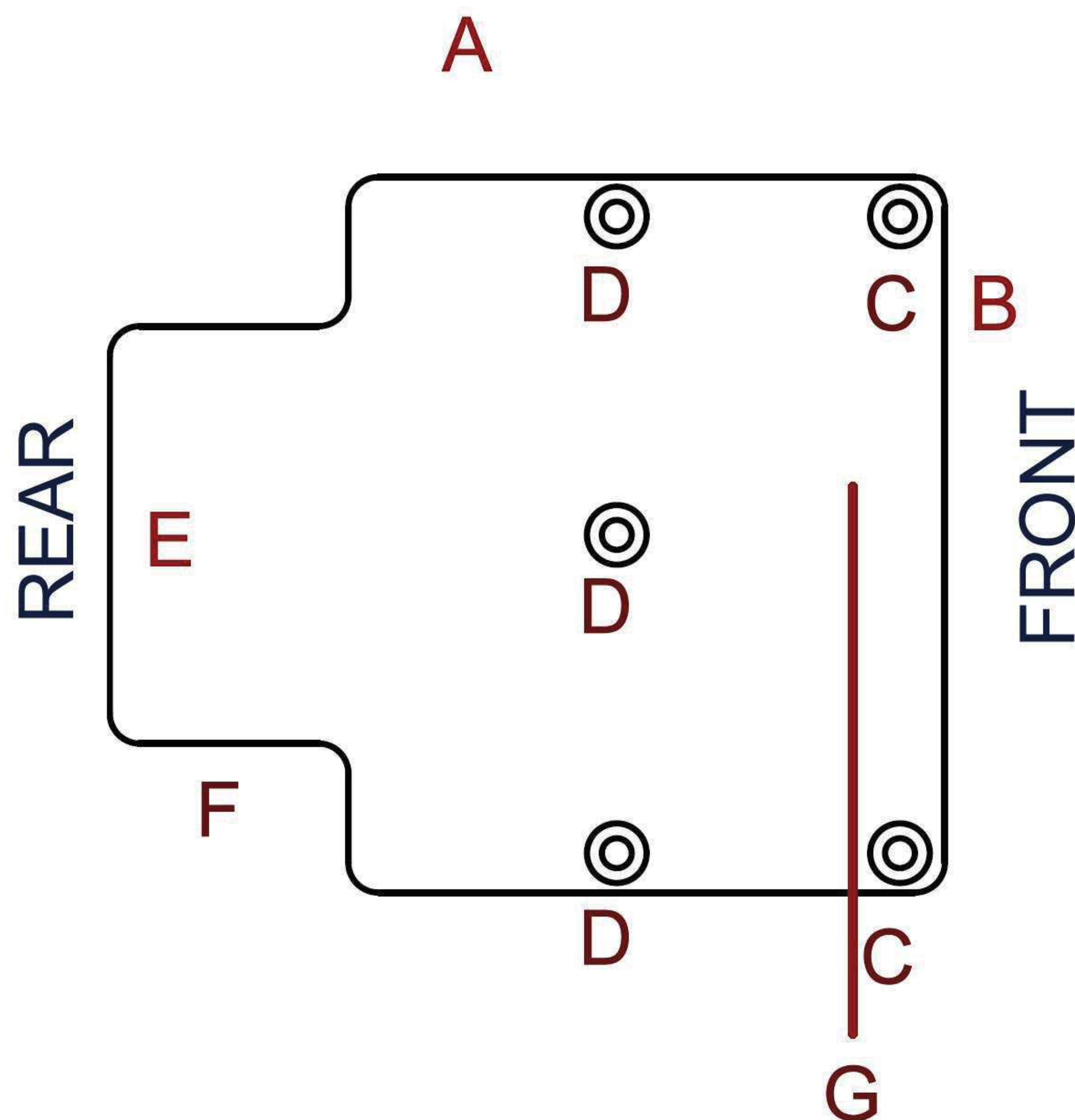

- A. Baseplate length overall - 3 1/2 inch or 89 mm.
- B. Baseplate width at front - 3 inch or 76 mm.
- C. Front mount points for baseplate - 2 screws from front - 5/32 inch or 5mm, spacing - 2 11/16 inch or 68 mm.
- D. Rear mount points for baseplate - 3 screws from front - 2 11/16 inch or 68 mm, spacing - 1 11/32 inch or 34 mm.
- E. Baseplate width at rear - 1 3/4 inch or 44.5 mm.
- F. Baseplate length at rear - 1 inch or 25.5 mm.
- G. Scale length from front - 5/16 inch or 8 mm.

Stetsbar bridge height measured at the top E saddle should be:

Minimum 11/16 inch 17.5mm

Maximum 13/16 inch or 20.5mm